



White Rodgers Intelli-Vent™ Guardian PowerVent Control

Effective October 2007, we transitioned to the White Rodgers (Intelli-Vent™) Thermostat Control for our standard Guardian PowerVent residential gas water heaters. This change affected both natural and LP gas models. Below is the troubleshooting step for each potential error code. In the event you display the code for a flammable vapor event, please call the technical support line at the phone number above.



Error 1

Indications	Display
An open earth ground circuit to the water heater.	
Troubleshooting	
<ol style="list-style-type: none"> 1. Check that the earth ground conductor is properly connected at the fuse box or breaker panel and the water heater. 2. Check that the grounding conductors on the water heater are properly connected and secure. 3. Check green grounding wire connection on side of control valve. 	

Error 2

Indications	Display
The self diagnostic test detected a wiring error or a high resistance to earth ground.	
Troubleshooting	
<ol style="list-style-type: none"> 1. Check for proper connection of the line neutral and line hot wires. 2. Check that the appliance is securely connected to earth ground. 	

Error 3

Indications	Display
The pressure switch remained closed longer than 5 seconds after the call for heat began. This error code will appear within 5 seconds if the pressure switch will not open.	
Troubleshooting	
<ol style="list-style-type: none"> 1. The pressure switch wiring is incorrect. 2. The pressure switch has been jumpered. 3. The pressure switch is defective (contacts inside switch permanently closed) and must be replaced. 	





White Rodgers Intelli-Vent™ Guardian PowerVent Control

Error 4

Indications	Display
The pressure switch remained open longer than 5 seconds after the combustion blower energized.	
Troubleshooting	
<ol style="list-style-type: none"> 1. The pressure switch wiring is incorrect or disconnected. 2. The pressure switch tubing is not connected correctly or pinched off. 3. Obstructions or restrictions in the water heater exhaust venting. Remove venting and recycle to rule out venting. If unit goes to main burner, the venting is the problem. If the code repeats, replace inducer/pressure switch. 4. The vent over-temperature switch is activated or defective. 	

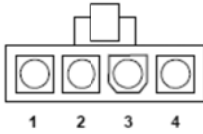
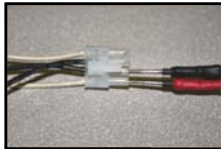
Error 5

Indications	Display
The self-diagnostic test has detected an error in the Hot Surface Igniter circuit.	
Troubleshooting	
<ol style="list-style-type: none"> 1. Check that the wiring harness Molex is connected and secure. 2. Disconnect the ignitor connector and measure the ignitor resistance with an ohmmeter between pins 1 and 2. Resistance should be between 11.5 and 18.8 ohms. 	
  	
<ol style="list-style-type: none"> 3. If the reading is incorrect, replace the Hot Surface Ignitor assembly. 4. If the above checks are good, replace the Intelli-Vent™ control. 	

Error 6

Indications	Display
The maximum number of ignition retries or recycles has been reached and the system is in lockout. (This means there was no flame rectification to the control to verify main burner.)	
Troubleshooting	
<ol style="list-style-type: none"> 1. Check if the gas supply is off or too low to operate. 2. Check the flame sense rod to see that it is located properly and free from contamination. Reposition the flame sense rod or lightly clean with an abrasive cloth. (See last page for positioning of flame rod.) 3. The Hot Surface Ignitor may not be positioned on the burner correctly. Reposition as necessary. (See last page for proper positioning of hot surface igniter and flame probe) 4. Low voltage to the water heater. (Verify the hot surface ignitor glows by recycling power and looking thru sight glass window. If you have a glowing ignitor, then your problem is probably fuel related.) 5. Thermal Release Device is damaged or missing. No oxygen in combustion chamber. 6. Inadequate fresh air to support combustion inside combustion chamber. 7. Main burner supply tube is blocked, bent or restricted; burner orifice is blocked or restricted. 	



White Rodgers Intelli-Vent™ Guardian PowerVent Control

Error 7

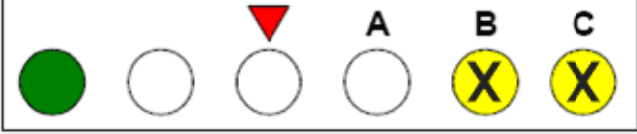
<p>Indications</p> <p>The self-diagnostic test found a problem with the gas valve driver circuit.</p>	<p>Display</p> 
<p>Troubleshooting</p> <ol style="list-style-type: none"> 1. Cycle power to the water heater off for 10 seconds and then back on. 2. If the above step did not clear the error, the Intelli-Vent™ control must be replaced. <p>Note: There are no further tests to conduct when the control fails one of its “self-diagnostic” tests. If the valve thinks there is something wrong; then the recourse is to replace the control.</p>	

Error 8

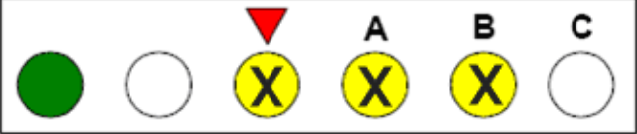
<p>Indications</p> <p>The self-diagnostic test found a problem with the internal micro computer</p>	<p>Display</p> 
<p>Troubleshooting</p> <ol style="list-style-type: none"> 1. Cycle power to the water heater off for 10 seconds and then back on. 2. If the above step did not clear the error, the Intelli-Vent™ control must be replaced. <p>Note: There are no further tests to conduct when the control fails one of its “self-diagnostic” tests. If the valve thinks there is something wrong; then the recourse is to replace the control.</p>	

Error 9

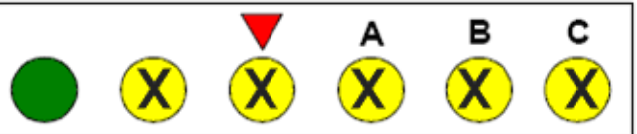
<p>Indications</p> <p>The self-diagnostic test found a problem with the internal circuit</p>	<p>Display</p> 
<p>Troubleshooting</p> <ol style="list-style-type: none"> 1. Cycle power to the water heater off for 10 seconds and then back on. 2. If the above step did not clear the error, the Intelli-Vent™ control must be replaced. <p>Note: There are no further tests to conduct when the control fails one of its “self-diagnostic” tests. If the valve thinks there is something wrong; then the recourse is to replace the control.</p>	



White Rodgers Intelli-Vent™ Guardian PowerVent Control

Error 10

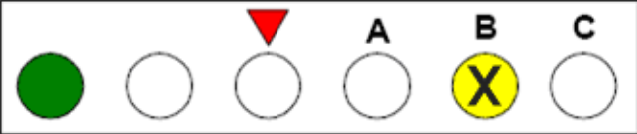
Indications Flame signal sensed out of proper sequence. (The flame probe sensed the presence of flame when it was not supposed to.)	Display 
Troubleshooting <ol style="list-style-type: none"> 1. Cycle power to the water heater off for 10 seconds and then back on. 2. If the above step did not clear the error, the Intelli-Vent™ control must be replaced. 	

Error 11

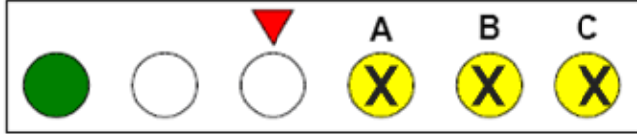
Indications High temperature thermal cut-off (ECO) switch is tripped. (This one time use device trips when the water temperature exceeds 195° F.)	Display 
Troubleshooting <ol style="list-style-type: none"> 1. Cycle power to the water heater off for 10 seconds and then back on. 2. If the above step did not clear the error, the Intelli-Vent™ control must be replaced. 	

Error 12

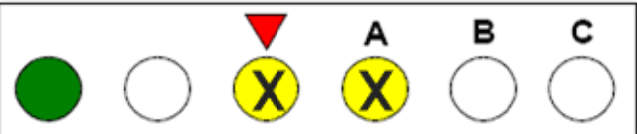
Indications The self diagnostic test has indicated one of the temperature adjustment buttons is stuck closed.	Display 
Troubleshooting <ol style="list-style-type: none"> 1. Make sure that there are no objects leaning against the front of the control 2. Lightly press and release each of the buttons once. 3. If the above actions do not clear the error, the control will continue to regulate water temperature at the last setting, but you are not able to change settings unless you replace the Intelli-Vent™ control. 	

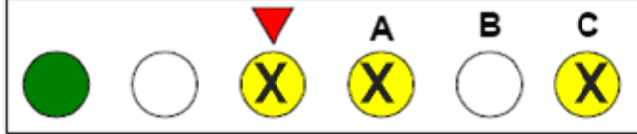

Error 13

Indications The self-diagnostic test has detected that the water temperature sensor is either open or short circuited.	Display 
Troubleshooting <ol style="list-style-type: none"> 1. Cycle power to the water heater off for 10 seconds and then back on. 2. If the above step did not clear the error, the Intelli-Vent™ control must be replaced. <p>Note: There are no further tests to conduct when the control fails one of its “self-diagnostic” tests. If the valve thinks there is something wrong; then the recourse is to replace the control.</p>	



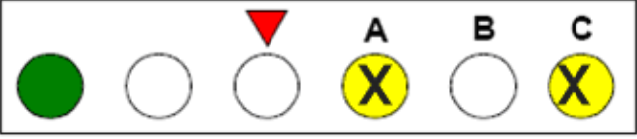

White Rodgers Intelli-Vent™ Guardian PowerVent Control

Error 14

Indications	Display
<p>The self-diagnostic test found a problem with the Flammable Vapor Sensor. (This is <u>not</u> a flammable vapor event. It may be caused by disconnecting the FV sensor Molex, or the FV sensor itself. This includes both short and open electrical connections.)</p>	
<p>Troubleshooting</p>	
<ol style="list-style-type: none"> 1. Check all FV sensor wiring harness connections; and the connections to the back of the sensor. 2. Cycle power to the water heater off for 10 seconds and then back on. 3. If no wiring problems are found, the Flammable Vapor Sensor must be checked. <ol style="list-style-type: none"> a. Disconnect the FV sensor Molex and measure the resistance of the sensor between the two black wires 2 and 3. If the resistance is less than 9k OHMS or greater than 45k OHMS, then replace the sensor. b. If the FV sensor is between 9K OHMS and 45K OHMS and the code will not clear by recycling power, replace the Intelli-Vent™ control. 	
<div style="display: flex; justify-content: space-around;">   </div>	

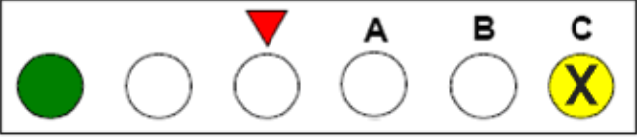
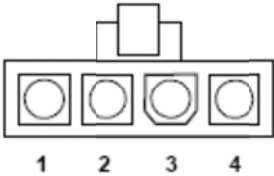
Error 15

Indications	Display
<p>The control detected the presence of flammable vapors near the water heater and entered lock out.</p> <p>This is a permanent lockout and cannot be cleared by cycling power. Control may be reset.</p>	
<p>Troubleshooting</p>	
<ol style="list-style-type: none"> 1. Disconnect the FV sensor Molex and measure the resistance of the FV sensor between the two black wires 2 and 3. 	
<div style="display: flex; justify-content: space-around;">   </div> <ol style="list-style-type: none"> 2. Write down this resistance and call the technical support line at 800-432-8373 for further instructions. 3. The control is field resettable; however, we probably need to replace the FV sensor if the sensor is out of tolerance. 	



White Rodgers Intelli-Vent™ Guardian PowerVent Control

Flickering Lights on Control

Indications	Display
All light flicker in an erratic pattern. This condition is caused by an erratic or lost neutral connection.	All light flicker in an erratic pattern.
Troubleshooting	
<p>1. Measure for 120V between the long and short slots on the wall plug. Check for loose wires inside the wall plug if needed.</p> <div data-bbox="228 537 537 997" data-label="Image"> </div> <p>2. Turn blower ON. Measure for 120V between the red and white wires on the bottom of the control as indicated in this photo:</p> <div data-bbox="1029 701 1386 957" data-label="Image"> </div> <p>3. If you have 120V between the red and white wires, replace the control.</p> <p>4. IF you have 120V at the wall and not at the control, then replace the blower motor.</p>	



TECHNICAL SERVICE DEPARTMENT
Technical Service Bulletin
1-800-432-8373

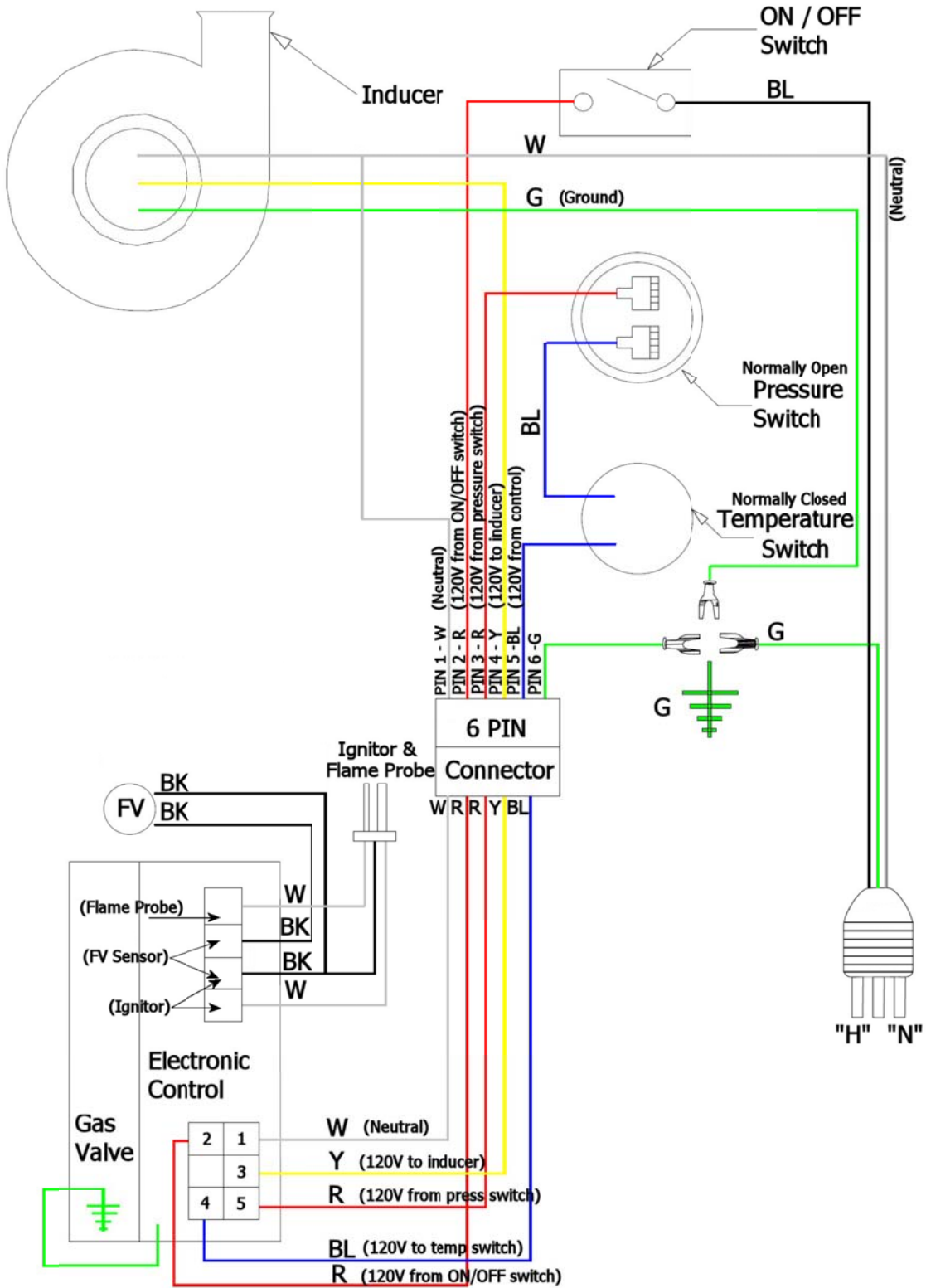



White Rodgers Intelli-Vent™ Guardian PowerVent Control

Flame Sensor Rod Position

The table and diagrams below show the proper placement of the flame sensor rod for the Guardian PowerVent with the White Rodgers control.

Flame Sensor Rod Positions (Nominal)		
Models	"X"	"Y"
Natural Gas	1/2"	(+)1/32" (above burner lip)
Propane Gas	7/16"	0" (even with burner lip)

X positioning (top view)

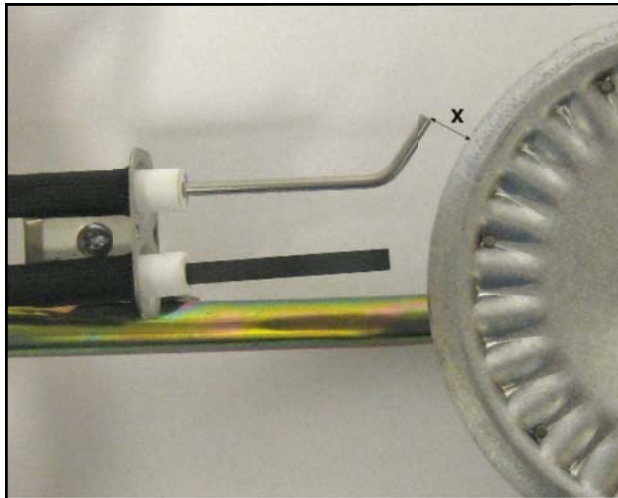

Y positioning (side view distance from top of burner plate)

