

Use & Care Manual

With Installation Instructions for the Installer

Direct Vent Gas - FVIR Certified Water Heaters

40 and 50 Gallon Vertical Co-Axial Vent System

The purpose of this manual is twofold: one, to provide the installer with the basic directions and recommendations for the proper installation and adjustment of the water heater; and two, for the owner-operator, to explain the features, operation, safety precautions, maintenance and troubleshooting of the water heater. This manual also includes a parts list.

It is very important that all persons who are expected to install, operate or adjust this water heater read the instructions carefully so they may understand how to perform these operations. If you do not understand these instructions or any terms within it, seek professional assistance.

Any questions regarding the operation, maintenance, service or warranty of this water heater should be directed to the seller from whom it was purchased. If additional information is required, refer to the section on "If You Need Service."

Do not destroy this manual. Please read carefully and keep in a safe place for future reference.



Recognize this symbol as an indication of Important Safety Information!



California Proposition 65 Warning: This product contains chemicals known to the State of California to cause cancer, birth defects or other reproductive harm.

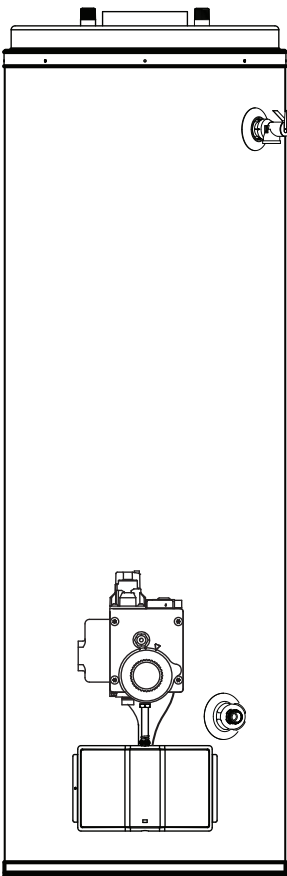

WARNING: If the information in these instructions is not followed exactly, a fire or explosion may result causing property damage, personal injury or death.

▲ FOR YOUR SAFETY!

—Do not store or use gasoline or other flammable vapors or liquids or other combustible materials in the vicinity of this or any other appliance. To do so may result in an explosion or fire.

—WHAT TO DO IF YOU SMELL GAS

- Do not try to light any appliance.
- Do not touch any electrical switch; do not use any phone in your building.
- Immediately call your gas supplier from a neighbor's phone. Follow the gas supplier's instructions.

- If you cannot reach your gas supplier, call the fire department.
- Do not return to your home until authorized by the gas supplier or fire department.
- Improper installation, adjustment, alteration, service or maintenance can cause injury, property damage or death. Refer to this manual. Installation and service must be performed by a qualified installer, service agency or the gas supplier.



Safety Information

Safety Precautions	3-6
LP Gas Models	5

Installation Instructions

Location	7
Water Supply Connections .	10
Gas Supply	12
Pipe Installation	12
Heat Traps	13
Installation Checklist	14

Operating Instructions

Lighting Instructions	15
Water Temperature	16, 17

Care and Cleaning

Draining	18
Burner Inspection	19
Extended Shut-Down	19

Troubleshooting Tips

Before You Call For Service	20, 21
--	--------

Customer Service

Parts List	22
Conversion Instructions	23-26
If You Need Service	28



FOR YOUR RECORDS

Write the model and serial numbers here:

You can find them on a label on the appliance.

Staple sales slip or cancelled check here.

Proof of the original purchase date is needed to obtain service under the warranty.



READ THIS MANUAL

Inside you will find many helpful hints on how to use and maintain your water heater properly. A little preventive care on your part can save you time and money over the life of your water heater.

You'll find many answers to common problems in the Troubleshooting Guide. If you review the chart of Troubleshooting Tips first, you may not need to call for service.



READ THE SAFETY INFORMATION

Your safety and the safety of others are very important. There are many important safety messages in this manual and on your appliance. Always read and obey all safety messages.



This is the safety alert symbol. Recognize this symbol as an indication of Important Safety Information! This symbol alerts you to potential hazards that can kill or hurt you and others.

All safety messages will follow the safety alert symbol and either the word "DANGER", "WARNING", "CAUTION" or "NOTICE".

These words mean:

▲ DANGER:

An imminently hazardous situation that will result in death or serious injury.

▲ WARNING:

A potentially hazardous situation that could result in death or serious injury and/or damage to property.

▲ CAUTION:

A potentially hazardous situation that may result in minor or moderate injury.

NOTICE:

Attention is called to observe a specified procedure or maintain a specific condition.

IMPORTANT SAFETY INFORMATION. READ ALL INSTRUCTIONS BEFORE USING.

Be sure to read and understand the entire Use and Care Manual before attempting to install or operate this water heater. It may save you time and money. Pay particular attention to the Safety Instructions. Failure to follow these warnings could result in serious bodily injury or death. Should you have problems understanding the instructions in this manual, or have any questions, STOP, and get help from a qualified service technician, or the local gas utility.

DANGER!

INSTALL THE VENTING SYSTEM AND PROPERLY VENT THE WATER HEATER...



Failure to install the venting system and properly vent the water heater to the outdoors as outlined in the Venting Section of the Installation Instructions in this manual can result in unsafe operation of the water heater. To avoid the risk of fire, explosion, or asphyxiation from carbon monoxide, never operate this water heater unless it is properly vented and has an adequate air supply for proper operation. Be sure to inspect the vent system for proper installation at initial start-up; and at least annually thereafter. Refer to the Care and Cleaning section of this manual for more information regarding vent system inspection.

WARNING!



Gasoline, as well as other flammable materials and liquids (which include, but are not limited to (adhesives, solvents, paint thinners etc.), and the vapors they produce are extremely dangerous. DO NOT handle, use or store gasoline or other flammable or combustible materials anywhere near or in the vicinity of a water heater or any other appliance. Be sure to read and follow the warning label pictured below and other labels on the water heater, as well as the warnings printed in this manual. Failure to do so can result in property damage, bodily injury or death.



IMPORTANT SAFETY INFORMATION. READ ALL INSTRUCTIONS BEFORE USING.



! DANGER!

WATER TEMPERATURE SETTING

Safety and energy conservation are factors to be considered when selecting the water temperature setting of water heater's thermostat. Water temperatures above 125°F can cause severe burns or death from scalding. Be sure to read and follow the warnings outlined on the label pictured below. This label is also located on the water heater.

DANGER

Water temperature over 125° F can cause severe burns instantly or death from scalds.

Children, disabled and elderly are at highest risk of being scalded.

See instruction manual before setting temperature at water heater.

Feel water before bathing or showering.

Temperature limiting valves are available, see manual.

Time/Temperature Relationship in Scalds

Water Temperature	Time To Produce a Serious Burn
120°F	More than 5 minutes
125°F	1½ to 2 minutes
130°F	About 30 seconds
135°F	About 10 seconds
140°F	Less than 5 seconds
145°F	Less than 3 seconds
150°F	About 1½ seconds
155°F	About 1 second

Table courtesy of Shriners Burn Institute

The chart shown above may be used as a guide in determining the proper water temperature for your home.

! DANGER: Households with small children, disabled, or elderly persons may require a 120°F or lower thermostat setting to prevent contact with "HOT" water.

Maximum water temperatures occur just after burner has shut off. To find water temperature being delivered, turn on a hot water faucet and place a thermometer in the water stream and read the thermometer. (See page 16 and 17 for more details.)

The temperature of the water in the heater can be regulated by setting the temperature dial on the front of the gas control (thermostat). To comply with safety regulations the thermostat was set at its lowest setting before the water heater was shipped from the factory.

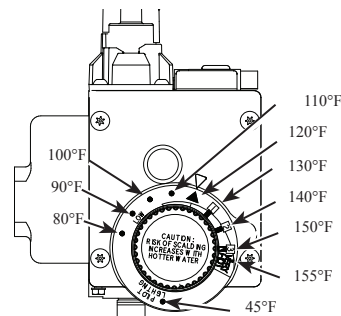

Temperatures are approximate

The illustration at the left details the approximate water temperature for each mark on the Gas Control (Thermostat) Temperature Dial.

NOTICE: Mixing valves are available for reducing point of use water temperature by mixing hot and cold water in branch water lines. Contact a licensed plumber or the local plumbing authority for further information.

! DANGER: Hotter water increases the potential for Hot Water SCALDS.

DANGER!

LIQUEFIED PETROLEUM (LP - PROPANE OR BUTANE) AND NATURAL GAS MODELS



LP and natural gas have an odorant added to aid in detecting a gas leak. Some people may not physically be able to smell or recognize this odorant. If you are unsure or unfamiliar with the smell of LP or natural gas, ask the gas supplier. Other conditions, such as “odorant fade”, which causes the odorant to diminish in intensity, can also hide or camouflage a gas leak.

- This water heater is supplied with a thermostatic gas valve that is convertible from LP to natural gas. Be sure to read and carefully follow the Conversion Instructions included in this manual when converting the valve from one type of gas to another.
- After conversion, be certain that the gas supplied to the heater is the type that the valve has been converted for (LP for heaters converted to LP use, and natural gas for heaters converted to natural gas use). This water heater will not operate safely if connected to a fuel type other than the one the gas valve is converted for.
- LP gas must be used with great caution. It is heavier than air and will collect first in lower areas making it hard to detect at nose level.
- Before attempting to light the water heater, make sure to look and smell for gas leaks. Use a soapy solution to check all gas fittings and connections. Bubbling at a connection indicates a leak that must be corrected. When smelling to detect an LP leak, be sure to sniff near the floor also.
- Gas detectors are recommended in LP and natural gas applications and their installation should be in accordance with the manufacturer’s recommendations and/or local laws, rules, regulations or customs.
- It is recommended that more than one method, such as soapy solution, gas detectors, etc. be used to detect leaks in LP gas applications.

 **DANGER:** If a gas leak is present or suspected:

- Do not attempt to find the cause yourself.
- Do not try to light any appliance.
- Do not touch any electrical switch.
- Do not use any phone in your building.
- Leave the house immediately and make sure your family and pets leave also.
- Leave the doors open for ventilation and contact the gas supplier, a qualified service agency or the fire department.
- Stay away from the house (or building) until the service call has been made, the leak is corrected and a qualified agency has determined the area to be safe.

IMPORTANT SAFETY INFORMATION. READ ALL INSTRUCTIONS BEFORE USING.

WARNING!

For your safety, the information in this manual must be followed to minimize the risk of fire or explosion, electric shock, or to prevent property damage, personal injury, or loss of life.



FOR INSTALLATIONS IN THE STATE OF CALIFORNIA

California Law requires that residential water heaters must be braced, anchored or strapped to resist falling or horizontal displacement due to earthquake motions. For residential water heaters up to 52 gallon capacity, a brochure with generic earthquake bracing instructions can be obtained from: Office of the State Architect, 1102 Q Street, Suite 5100, Sacramento, CA 95814 or you may call 916-445-8100 or ask a water heater dealer.

However, applicable local codes shall govern installation. For residential water heaters of a capacity greater than 52 gallons, consult the local building jurisdiction for acceptable bracing procedures.



SAFETY PRECAUTIONS

Have the installer show you the location of the gas shut-off valve and how to shut it off if necessary. Turn off the manual shut-off valve if the water heater has been subjected to overheating, fire, flood, physical damage or if the gas supply fails to shut off.

- Read this manual entirely before installing or operating the water heater.
- Use this appliance only for its intended purpose as described in this Use and Care Manual.
- Be sure your appliance is properly installed by a qualified technician in accordance with the provided installation instructions.
- **Do not** attempt to repair or replace any part of your water heater unless it is specifically recommended in this manual. All other servicing should be referred to a qualified technician.



READ AND FOLLOW THIS SAFETY INFORMATION CAREFULLY.

SAVE THESE INSTRUCTIONS

Installing the water heater.

This water heater is suitable for Direct Vent Installation in a Manufactured Home (Mobile Home) and other non-Manufactured Home (non-Mobile Home) Installations. This water heater must be installed in accordance with these instructions, provided with the Co-Axial Roof Jack assembly, local codes, utility company requirements, and/or in the absence of local codes, use the latest addition of the American National Standard/National Fuel Gas Code. A copy can be purchased from either the American Gas Association, 400 N. Capital Street NW, Washington, DC 20001 as ANSI Standard Z223.1 or National Fire Protection Association, 1 Batterymarch Park, Quincy, MA 02269 as booklet NFPA 54. This product also meets the requirements of Title 24 CFR Part 3280.

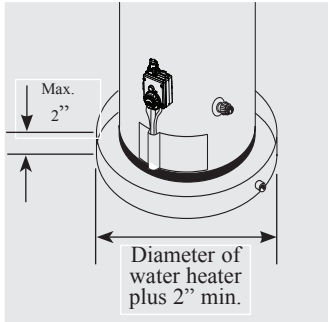

The auxiliary catch pan installation **MUST** conform to local codes.

Location

The water heater should not be located in an area where leakage from the tank or connections will result in damage to the area adjacent to the heater or to lower floors of the structure.

When such areas cannot be avoided it is recommended that a suitable catch pan, adequately drained, must be installed under the water heater.

Catch pan kits are available from the store where the water heater was purchased, or any water heater distributor.

This water heater must be installed within an enclosure so as to separate the water heater's combustion and venting system from the interior atmosphere of the home. The enclosure must be large enough to allow for bracing. Front clearance must also be provided for inspection and servicing of the water heater.

Make certain the floor underneath the water heater is strong enough to sufficiently support the weight of the water heater once it is filled with water.

A gas fired water heater or any other appliance should not be installed in a space where liquids which give off flammable vapors are to be used or stored. Such liquids include gasoline, LP gas (butane or propane), paint or adhesives and their thinners, solvents or removers.

Because of natural air movement in a room or other enclosed space, flammable vapors can be carried some distance from where liquids which give off flammable vapors are to be used or stored. The open flame of the water heater's pilot or main burner can ignite these vapors.

The water heater must be located so it is not subject to physical damage, for example, by moving vehicles, area flooding, etc.

All air for combustion must be obtained from the outside atmosphere, and the products of combustion (flue gases) must be discharged directly to the outside atmosphere through the gas vent Co-Axial Roof Jack assembly. Because the water heater is of the sealed

combustion type, a vent hood is not required between the water heater and the Co-Axial Roof Jack.

Refer to installation illustration as shown in this manual.

Install the water heater with minimum clearance from combustible construction of 0 inch sides and rear; 2 inches from front of control; 12 inches from ceiling. If clearances stated on the Instruction/Warning label, located on the front of the water heater, differ from the aforementioned clearances, install heater according to the clearances stated on the Instruction/Warning label.

The water heater may be installed on combustible flooring, but not directly on carpeting.

If the water heater must be installed on carpeting, place a wood or metal panel beneath the water heater extending beyond its full width and depth at least 3 inches in all directions. If the water heater is installed in an alcove or closet, the entire floor must be covered by the wood or metal panel. A minimum of 24" clearance from the front and top should be available for adequate inspection and servicing.

⚠ CAUTION: Provisions should be made so that in the event the water heater or one of its fittings were to leak, the resulting flow of water will not cause damage to the home. It is recommended that a suitable catch pan, adequately drained, be installed under the water heater.

⚠ CAUTION: DO NOT subject the water heater to any water distribution system air pressure test. The water heater should either be isolated with valves at the inlet and outlet water connections or disconnected during the test. Failure to properly isolate the water heater during an air pressure test presents a hazard to life and property. With a water pressure test the water heater need not be isolated.

⚠ WARNING: Combustible construction refers to adjacent walls and ceilings and should not be confused with combustible or flammable products and materials. Combustible and/or flammable products and materials should never be stored in the vicinity of this or any gas appliance.

Installing the water heater.

NOTICE: The water heater should not be installed near an air supply containing halogenated hydrocarbons.

NOTICE: The old roof jack must be replaced with the new co-axial roof jack.

Installation Methods

- 1 Inspect shipment.** Inspect the water heater for possible shipping damage.
- 2 Placement of water heater.** Locate the water heater as desired, make certain the minimum clearances outlined in this manual are observed.
- 3 Combustion and ventilation air.** Air for combustion and ventilation must not be supplied from occupied spaces of the home. The air inlet must not be obstructed under any circumstances. Outside air is necessary for proper and safe operation of the water heater.
- 4 Openings for gas vent Co-Axial Roof Jack assembly.** Cut a 7 1/4 in. diameter hole in the ceiling and roof directly above the flue of the water heater.
- 5 Securing the water heater.** Secure the water heater using the provided metal straps. Attach them to the top pan and bottom pan of the water heater then fasten the straps to the adjacent wall on each side.
- 6 Gas vent Co-Axial Roof Jack.** The roof jack must be one of the models listed in this manual, and marked as approved by Underwriters Laboratories, Inc. The installation instructions supplied with each Co-Axial Roof Jack must be observed to obtain the proper roof jack installation.

The Gas Vent Roof Jack Assembly has a multi piece telescopic vent connector pipe consisting of an upper, center and lower section that must be pre-adjusted according to the following directions prior to final installation of the roof jack.

From the water heater location, measure the distance from the highest point on roof opening to the top of the water heater. Select correct size Co-Axial Roof Jack from Co-Axial Roof Jack Sizing Guide on Page 9, Dimension X. Remove the Co-Axial Roof Jack from its carton, and extend the center section of the inner most pipe to its maximum length by grasping the pipe and sliding the center section of pipe downward. Then extend

the lower section of the inner pipe in the same manner to its full extension. Silicone rubber sealing bands are provided and must be pulled down over the joints between the tubes to ensure a leak proof seal.

Apply a non-hardening mastic on the roof around the previously cut hole to form a weather tight seal with the roof flange of the Co-Axial Roof Jack Assembly. Insert the Co-Axial Roof Jack through the opening in roof from above, and fasten the flashing to the roof using the pre-punched holes in the flashing. The roof flange adjusts to accommodate installation on a pitched roof, (maximum allowable pitch is 8-12). For roof pitches greater than 8-12 an alternate roof jack can be purchased. Apply additional non-hardening mastic as required to complete the weather seal.

To complete the assembly of the Co-Axial Roof Jack Inner Pipe installation: Apply silicone sealant around the outside of the water heater flue pipe, then extend the lower section of the vent connector pipe by grasping the center section of pipe, ensuring that the silicone rubber seal remains in position over the joint, press it firmly downward until seated over the flue pipe protruding inside the water heater's top plenum. An improper seal can cause nuisance pilot outages. Secure the inner pipe to the top pan of the water heater by inserting the two screws through the brackets on each side.

To complete the assembly of the Co-Axial Roof Jack Outer Pipe installation: Extend the upper section down and over the lower section of the vent connector pipe by grasping the center section of pipe and pull downward, ensuring that the silicone rubber seal remains in position over the joint, press it firmly downward until seated outside the lip of the top plenum. Secure on each side with the two screws provided. Apply silicone sealant around the edge of the top plenum and outer pipe connection to ensure a good seal. An improper seal can cause nuisance pilot outages.

This water heater is suitable for Direct Vent Installation in a Manufactured Home (Mobile Home) and other non-Manufactured Home (non-Mobile Home) Installations. This water heater must be installed in accordance with these instructions, provided with the Co-Axial Roof Jack assembly, local codes, utility company requirements, and/or in the absence of local codes, use the latest addition of the American National Standard/National Fuel Gas Code. A copy can be purchased from either the American Gas Association, 400 N. Capital Street NW, Washington, DC 20001 as ANSI Standard Z223.1 or National Fire Protection Association, 1 Batterymarch Park, Quincy, MA 02269 as booklet NFPA 54. This product also meets the requirements of Title 24 CFR Part 3280.

NOTICE - All sizes of Co-Axial Roof Jack Assembly have an adjustable tilt Roof Flange to accommodate installation on a pitched roof. Maximum roof pitch is 8-12. For roof pitches greater than 8-12 an alternate roof jack can be purchased.

NOTICE: 12" Minimum recommended distance from the top of the water heater to the ceiling for servicing the water heater.

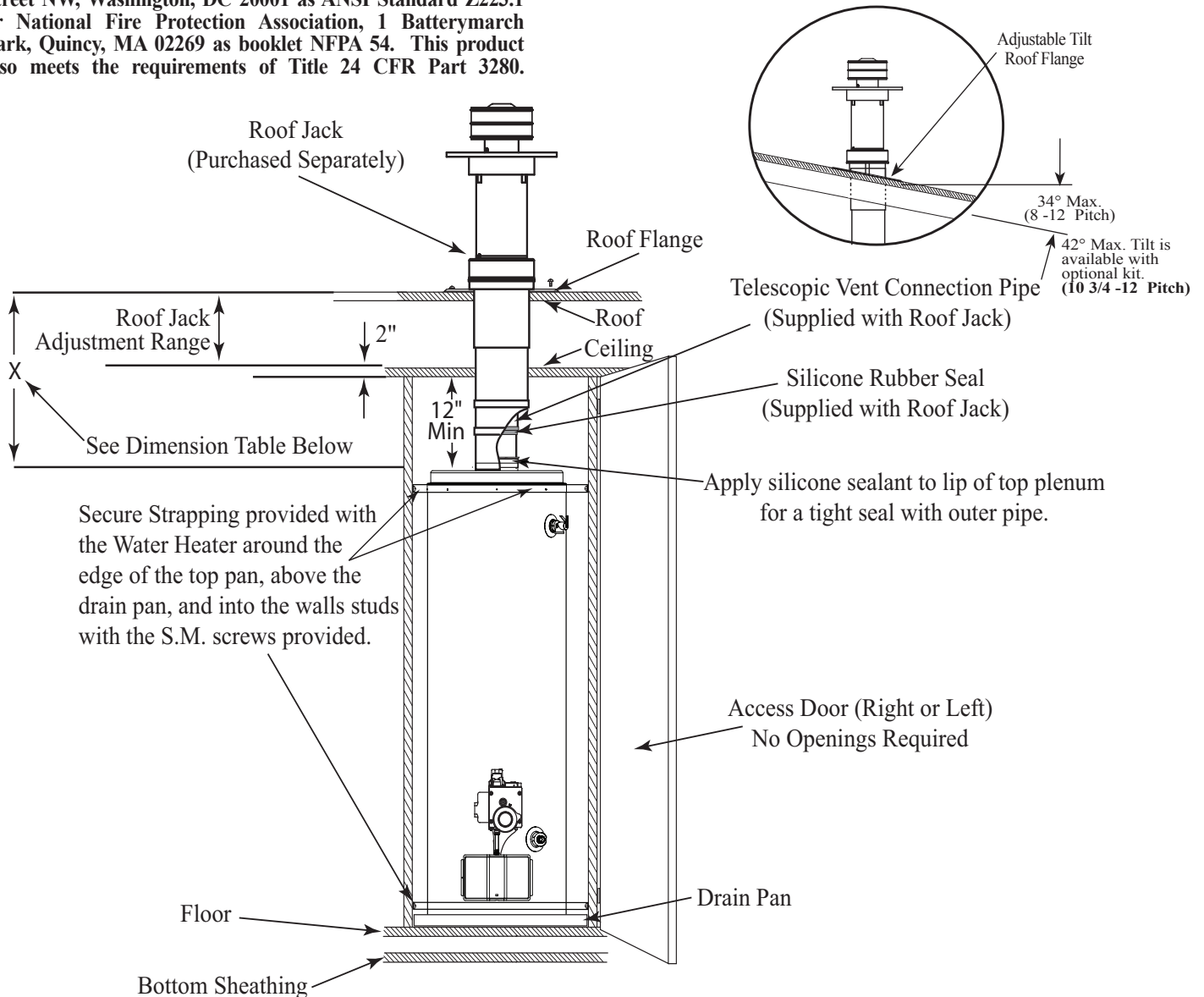

Co-Axial Roof Jack Sizing Table

34° Max. (8-12 Pitch) Roof Jack Kit Part Number	42° Max. (10 3/4-12 Pitch) Roof Jack Kit Part Number	Roof Jack Adjustment Range (See Dimension X)
AP14363A	AP14334A	24 - 37 Inches
AP14363B	AP14334B	33 - 68 Inches
AP14363C	AP14334C	45 - 97 Inches
AP14363D	AP14334D	60 - 130 Inches
AP14363E	AP14334E	72 - 160 Inches

Please note that the roof jack shown above is for illustration purposes only and may not resemble the actual unit in your kit.

Figure A - Top View of closet.

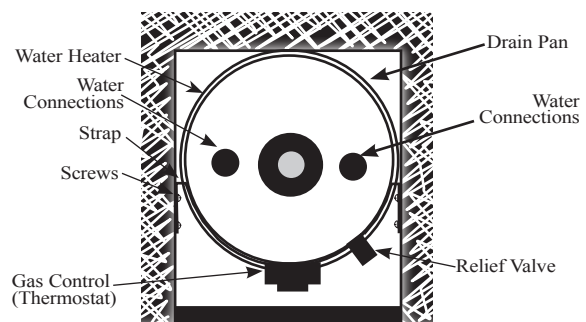

Installing the water heater.

Thermal Expansion

Determine if a check valve exists in the inlet water line. Check with your local water utility company. It may have been installed in the cold water line as a separate back flow preventer, or it may be part of a pressure reducing valve, water meter or water softener. A check valve located in the cold water inlet line can cause what is referred to as a “**closed water system**”. A cold water inlet line with no check valve or back flow prevention device is referred to as an “**open**” water system.

As water is heated, it expands in volume and creates an increase in the pressure within the water system. This action is referred to as “**thermal expansion**”. In an “**open**” water system, expanding water which exceeds the capacity of the water heater flows back into the city main where the pressure is easily dissipated.

A “**closed water system**”, however, prevents the expanding water from flowing back into the main supply line, and the result of “**thermal expansion**” can create a rapid

and dangerous pressure increase in the water heater and system piping. This rapid pressure increase can quickly reach the safety setting of the relief valve, causing it to operate during each heating cycle. Thermal expansion, and the resulting rapid and repeated expansion and contraction of components in the water heater and piping system, can cause premature failure of the relief valve, and possibly the heater itself. Replacing the relief valve **will not** correct the problem!

The suggested method of controlling thermal expansion is to install an expansion tank in the cold water line between the water heater and the check valve. The expansion tank is designed with an air cushion built in that compresses as the system pressure increases, thereby relieving the over pressure condition and eliminating the repeated operation of the relief valve. Other methods of controlling thermal expansion are also available. Contact your installing contractor, water supplier or plumbing inspector for additional information regarding this subject.

IMPORTANT: Do not apply heat to the HOT or COLD water connections. If sweat connections are used, sweat tubing to adapter before fitting adapter to the cold water connections on heater. Any heat applied to the cold water supply fittings will permanently damage the dip tube and/or heat traps.

Water Supply Connections

Refer to the illustration below for suggested typical installation. The installation of unions or flexible copper connectors is recommended on the hot and cold water connections so that the water heater may be easily disconnected for servicing if

necessary. The HOT and COLD water connections are clearly marked and are 3/4” NPT on all models. Install a shut-off valve in the cold water line near the water heater.

Typical Installation

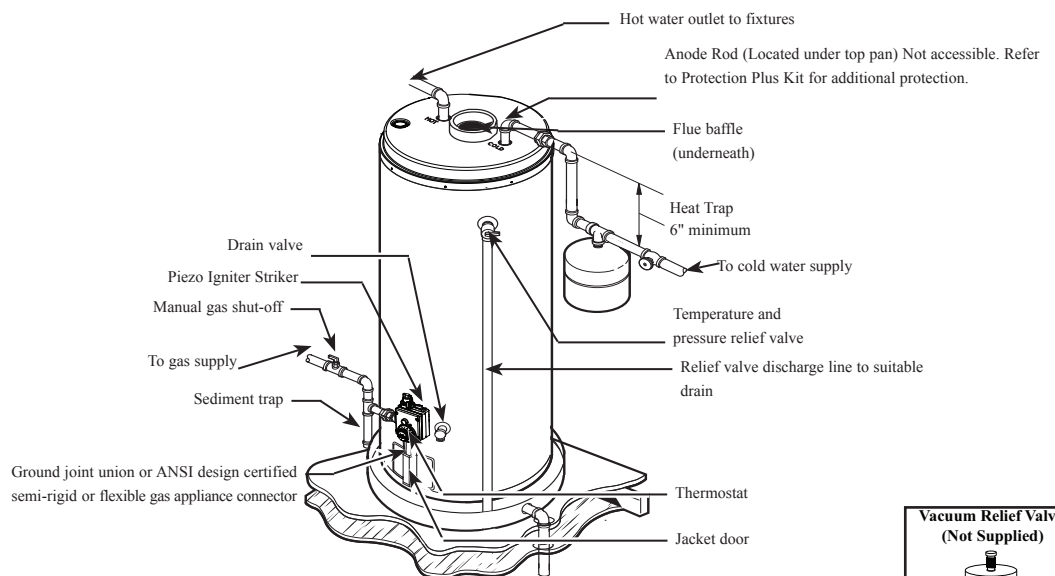

NOTICE: The National Fuel Gas Code (NFGC) mandates a manual gas shut-off valve: See (NFGC) for complete instructions. Local codes or plumbing authority requirements may vary from the instructions or diagrams provided and take precedent over these instructions.

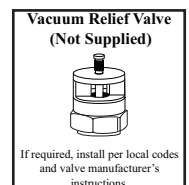

A new combination temperature and pressure relief valve, complying with the Standard for Relief Valves and Automatic Gas Shut-Off Devices for Hot Water Supply Systems, ANSI Z21.22, is supplied and must remain in the opening provided and marked for the purpose on the water heater. No valve of any type should be installed between the relief valve and the tank. Local codes shall govern the installation of relief valves.

Relief Valve

The pressure rating of the relief valve must not exceed 150 PSI, the maximum working pressure of the water heater as marked on the rating plate.

The BTUH rating of the relief valve must equal or exceed the BTUH input of the water heater as marked on its rating plate.

Position the outlet of the relief valve above a suitable open drain to eliminate potential water damage. Piping used should be of a type approved for hot

water distribution.

The discharge line must be no smaller than the outlet of the valve and must pitch downward from the valve to allow complete drainage (by gravity) of the relief valve and discharge line.

The end of the discharge line should not be threaded or concealed and should be protected from freezing. No valve of any type, restriction or reducer coupling should be installed in the discharge line.

▲WARNING: The tank must be full of water before heater is turned on. The water heater warranty does not cover damage or failure resulting from operation with an empty or partially empty tank.

To Fill the Water Heater

Make certain that drain valve is closed, then open the shut-off valve in the cold water supply line.

Open each hot water faucet slowly to allow the air to vent from the water heater and piping.

A steady flow of water from the hot water faucet(s) indicates a full water heater.

Condensation

Condensation can form on the tank when it is first filled with water. Condensation might also occur with a heavy water draw and very cold inlet water temperatures.

Drops of water falling on the burner can produce a sizzling or pinging sound.

This condition is not unusual, and will disappear after the water becomes heated. If, however, the condensation continues, examine the piping and fittings for possible leaks.

▲WARNING: Never use an open flame to test for gas leaks, as bodily injury, property damage or death could result.

Leak Testing

The water heater and its gas connections must be leak tested at normal operating pressures before it is placed in operation.

- 1 Turn on the manual gas shut-off valve near the water heater.
- 2 Use a soapy water solution to test for

leaks at all connections and fittings. Bubbles indicate a gas leak that must be corrected.

The factory connections to the gas control (thermostat) should also be leak tested after the water heater is placed in operation.

Pressure Testing the Gas Supply System

The water heater and its manual gas shut-off valve must be disconnected from the gas supply piping system during any high pressure testing of that system at pressures in excess of 1/2 psi (14" w.c.).

The water heater must be isolated from the gas piping system by closing the manual gas shut-off valve during any pressure testing of the gas supply piping at pressures equal to or less than 1/2 psi (14" w.c.).

Installing the water heater.

Gas Supply

Check the markings on the water heater's rating plate to be certain the type of gas being furnished corresponds to that for which the water heater is built. The water heater can be converted from natural gas to LP or vice versa. See the Conversion Instructions section of this manual.

The branch gas supply line to the water heater should be clean 1/2" black steel pipe or other approved gas piping material.

A ground joint union or ANSI design certified semi-rigid or flexible gas appliance connector should be installed in the gas line close to the water heater. The HUD code should be followed for installation and location of a manual shutoff valve. If lever type gas shut-offs are used, they shall be T-Handle type.

Compound used on the threaded joints of the gas piping must be of the type resistant to the action of LP gas. Use compound sparingly on male threads only.

Where a sediment trap is not incorporated as part of the appliance, a sediment trap shall be installed downstream of the equipment shutoff valve as close to the inlet of the appliance as practical at the time of the appliance installation. The sediment trap shall be either a tee fitting with a capped nipple in the bottom outlet or other device recognized as an effective sediment trap. Do not use excessive force (over 31.5 ft lbs.) in tightening the pipe joint at the thermostat inlet, particularly if teflon pipe compound is used, as the valve body may be damaged.

The inlet gas pressure to the water heater must not exceed 14" w.c. for natural or LP gas. For purposes of input adjustment, the minimum inlet gas pressure (with main burner on) is shown on the water heater rating plate. If high or low gas pressures are present, contact your gas supplier for correction.

If flexible connectors are used, the maximum length shall not exceed 36" (91 cm).

High Altitude

Ratings of gas appliances are based on sea level operation and need not be changed for installations at elevations up to 7,700 feet.

For installations above 7,700 feet, Please contact your local distributor or place of purchase for a high altitude model.

⚠ WARNING: Failure to install a water heater suitable for the altitude at the location it is intended to serve, can result in improper operation of the appliance resulting in property damage and/or, producing carbon monoxide gas, which could result in personal injury, or death.

Hot and Cold Pipe Insulation Installation

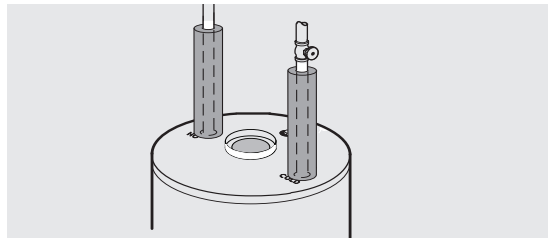

Typical vertical piping arrangement

For increased energy efficiency, some water heaters have been supplied with two 24" sections of pipe insulation.

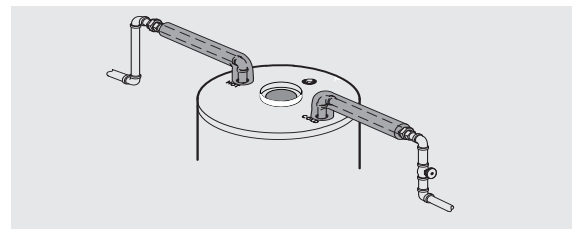

Typical horizontal piping arrangement

Please install the insulation, according to the illustrations above, that best meets your requirements.

T&P Insulation Installation

For increased energy efficiency, this water heater has been supplied with a 2 3/8" section of T&P insulation. Please install the insulation as shown below.

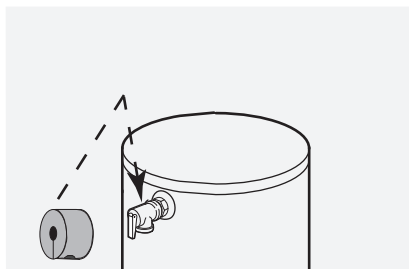

Typical Side Connect T & P Arrangement.

Slip the insulation cover over the T&P Valve through the center hole and align the hole in the side with the opening of the T&P Valve.

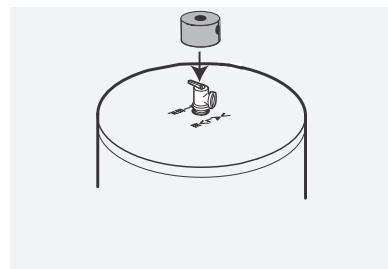

Typical Top Connect T & P Arrangement.

Ensure the T&P Valve opening is not obstructed by the insulation.

▲ WARNING: If local codes require external application of insulation blanket kits the manufacturer's instructions included with the kit must be carefully followed.

Insulation Blankets

Insulation blankets, available to the general public, for external use on gas water heaters are not necessary. The purpose of an insulation blanket is to reduce the standby heat loss encountered with storage tank heaters. This water heater meets or exceeds the National Appliance Energy Conservation Act standards with respect to insulation and standby loss requirements making an insulation blanket unnecessary.

The manufacturer's warranty does not cover any damage or defect caused by installation, attachment or use of any type of energy saving or other unapproved devices (other than those authorized by the manufacturer) into, onto or in conjunction with the water heater. The use of unauthorized energy saving devices may shorten the life of the water heater and may endanger life and property.

The manufacturer disclaims any responsibility for such loss or injury resulting from the use of such unauthorized devices.

▲ CAUTION: If local codes require the application of an external insulation blanket to this water heater, pay careful attention to the following so as not to restrict the proper function and operation of the water heater:

- Do not cover the operating or warning labels attached to the water heater or attempt to relocate them on the exterior of insulation blanket.
- Do not apply insulation to the top of the water heater. This will interfere with the safe operation of the vent.
- Do not cover the burner access door, jacket door, gas control (thermostat)/gas valve or pressure and temperature relief valve.

Heat Traps

For increased energy efficiency, some water heaters have been supplied with factory installed 3/4" NPT heat traps in the hot outlet line and cold water inlet line.

NOTICE: Do not apply heat to the HOT or COLD water connections. If sweat connections are used, sweat tubing to adapter before fitting adapter to the water connections on heater. Any heat applied to the water supply fittings will permanently damage the dip tube and/or heat traps.

During Installation of this water heater.....

DO

- DO check inlet gas pressure to ensure that it is within the range specified on the rating plate.
- DO provide adequate air for combustion and ventilation as discussed in the Use and Care Manual and the National Fuel Gas Code.
- DO maintain proper clearances to combustibles as specified on the instruction/warning label.
- DO ensure that the venting system complies with the guidelines found in the Use and Care Manual and National Fuel Gas Code.
- DO contact a qualified service technician if the pilot or main burner will not stay lit. The burner chamber is designed to be sealed utilizing a gasket and tamper resistant screws.

DON'T

- DON'T block or restrict the vent terminal.
- DON'T remove the Burner Access Door unless absolutely necessary. This should only be done by a qualified service technician. A new burner access door gasket must be installed on any burner access door that has been removed.
- DON'T install this water heater where standing water may occur. The base of the water heater is meant to be mounted on a dry surface.
- DON'T operate the water heater if the sight glass or burner access door grommet is damaged or broken.

Installation Checklist

A. Water Heater Location

- Water heater securely anchored.
- Close to area of vent.
- Indoors and protected from freezing temperatures.
- Proper clearance from combustible surfaces observed and water heater not installed on carpeted floor.
- Sufficient fresh air supply for proper operation of water heater.
- Air supply free of corrosive elements and flammable vapors.
- Provisions made to protect area from water damage.
- Sufficient room to service heater.
- Combustible materials, such as clothing, cleaning materials, rags, etc. clear of the base of the heater.

B. Water Supply

- Water heater completely filled with water.
- Air purged from water heater and piping.
- Water connections tight and free of leaks.

C. Gas Supply

- Gas line equipped with shut-off valve, union and sediment trap.
- Approved pipe joint compound used.
- Soap and water solution used to check all connections and fittings for possible gas leak.
- Gas Company inspected installation (if required).
- After conversion, be certain the gas supplied to the heater is the type the valve has been converted for (LP for heaters converted to LP use, and natural gas for heaters converted to natural gas use).

D. Relief Valve

- Temperature and Pressure Relief Valve properly installed and discharge line run to open drain.
- Discharge line protected from freezing.

E. Venting

- Flue baffle properly hung in top of heater's flue.
- Vent connector(s) securely fastened together with screws.
- Air tube and vent tube properly installed.
- Vent terminal, air tube sealed with silicone bands and sealants.
- Air tube securely fastened with screws.

Lighting the water heater.

Before operating this water heater, be sure to read and follow the instructions on the label pictured below and all other labels on the water heater, as well as the warnings printed in this manual. Failure to do so can result in unsafe operation of the water heater resulting in property damage, bodily injury, or death. Should you have any problems reading or following the instructions in this manual, STOP, and get help from a qualified person.

FOR YOUR SAFETY READ BEFORE OPERATING

▲ WARNING: If you do not follow these instructions and the Use & Manual instructions exactly, a fire or explosion may result causing property damage, personal injury or loss of life.

- A. This appliance has a pilot which is lit by a piezo-electric spark gas ignition system. Do **NOT** open the inner door of this appliance and try to light the pilot by hand!
- B. **BEFORE LIGHTING** smell all around the appliance area for gas. Be sure to smell next to the floor because some gas is heavier than air and will settle on the floor.
WHAT TO DO IF YOU SMELL GAS
 - Do not try to light any appliance.
 - Do not touch any electric switch; do not use any phone in your building.
 - Immediately call your gas supplier from a neighbor's phone. Follow the gas supplier's instructions.
- C. Use only your hand to turn the gas control knob. Never use tools. If the knob will not turn by hand, don't try to repair it, call a qualified service technician. Force or attempted repair may result in a fire or explosion.
- D. Do not use this appliance if any part has been under water. Immediately call a qualified installer or service agency to replace a flooded water heater. Do not attempt to repair the unit! It must be replaced!

LIGHTING INSTRUCTION

1. STOP! Read safety information above on this label.
2. Set the thermostat dial to the lowest setting by turning the thermostat dial clockwise until it stops. **DO NOT FORCE.**
3. Slightly depress the gas control knob and turn clockwise to "OFF" position. Note: Knob cannot be turned from "PILOT" position unless pushed down slightly. Do not use force.
4. Wait five (5) minutes to clear out any gas. If you smell any gas, STOP! follow "B" in the safety information above on this label. If you do not smell gas, go to the next step.
5. Remove the outer door from the water heater. Do not attempt to remove the inner door.
6. Locate the piezo-electric spark generator which is located on top of the combination gas control.
7. Turn the gas control knob counter-clockwise to the "PILOT" position.
8. Depress and hold the gas control knob all the way down. Immediately depress the piezo-electric spark generator button several times until the pilot is lit. The pilot flame can only be seen through the sight glass window located on the inner door.
9. Continue to hold down the gas control knob for about one (1) minute after the pilot is lit. If it goes out repeat steps 3 to 9.
 - If the gas control knob does not pop up when released, stop and immediately call your service technician or gas supplier.
 - If the pilot will not stay lit after several tries, turn the gas control knob clockwise to "OFF" and call your service technician or gas supplier.
10. Once the pilot flame is established replace the outer door.
11. Turn the gas control knob counter-clockwise to the "ON" position. Warning do not use gas control knob to regulate gas flow to burner.
12. Set the thermostat dial to desired setting by turning dial counter-clockwise. The preferred starting point for temperature setting is to align the two triangular pointers on the dial and control face.



TO TURN GAS OFF TO THE APPLIANCE

1. Set the thermostat dial to the lowest setting by turning the thermostat dial clockwise until it stops. **DO NOT FORCE.**
2. Slightly depress the gas control knob and turn clockwise to "OFF POSITION". Note: Knob cannot be turned from "PILOT" position unless pushed down slightly. Do not use force.

Operating the water heater.

▲ CAUTION: Hydrogen gas can be produced in a hot water system served by this water heater that has not been used for a long period of time (generally two weeks or more). **HYDROGEN GAS IS EXTREMELY FLAMMABLE!!** To dissipate such gas and to reduce risk of injury, it is recommended that the hot water faucet be opened for several minutes at the kitchen sink before using any electrical appliance connected to the hot water system. If hydrogen is present, there will be an unusual sound such as air escaping through the pipe as the water begins to flow. Do not smoke or use an open flame near the faucet at the time it is open.

Safety Precautions

- A** Do not turn off manual gas shut-off valve if water heater has been subjected to overheating, fire, flood, physical damage or if the gas supply fails to shut off.
 - B** Do Not turn on water heater unless it is filled with water.
 - C** Do Not turn on water heater if cold water supply shut-off valve is closed.
 - D** Do Not allow combustible materials such as newspaper, rags or mops to accumulate near water heater.
 - E** Do Not store or use gasoline or other flammable vapors and liquids, such as adhesives or paint thinner, in vicinity of this or any other appliance. If such flammables must be used, open doors and windows for ventilation, and all gas burning appliances in the vicinity should be shut off including their pilot lights, to avoid vapors lighting.
- NOTICE:** Flammable vapors may be drawn by air currents from surrounding areas to the water heater.
- F** If there is any difficulty in understanding or following the Operating Instructions or the Care and Cleaning section, it is recommended that a qualified person or serviceman perform the work.
-

Water Temperature Setting

▲ DANGER: There is a hot water scald potential if the gas control (thermostat) is set too high. Households with small children, disabled, or elderly persons may require a 120°F or lower thermostat setting to prevent contact with HOT water.

The temperature of the water in the water heater can be regulated by setting the temperature dial on the front of the gas control (thermostat).

Safety and energy conservation are factors to be considered when selecting the water temperature setting of the water heater's gas control (thermostat). The lower the temperature setting, the greater the savings in energy and operating costs.

To comply with safety regulations the gas control (thermostat) was factory set at it's lowest setting before the water heater is shipped from the factory. This is the recommended starting point.

Water temperatures above 125°F can cause severe burns or death from scalding. Be sure to read and follow the warnings outlined in this manual and on the label on the water heater. This label is located on the water heater near the gas control (thermostat).

Mixing valves for reducing point of use water temperature by mixing hot and cold water in branch water lines are available. Contact a licensed plumber or the local plumbing authority for further information. (See page 4 for more details.)

The chart on the next page may be used as a guide in determining the proper water temperature for your home.

Operating the water heater.

Time/Temperature Relationship in Scalds

Water Temperature	Time To Produce a Serious Burn
120°F	More than 5 minutes
125°F	1½ to 2 minutes
130°F	About 30 seconds
135°F	About 10 seconds
140°F	Less than 5 seconds
145°F	Less than 3 seconds
150°F	About 1½ seconds
155°F	About 1 second

Table courtesy of Shriners Burn Institute

Water Temperature Setting...

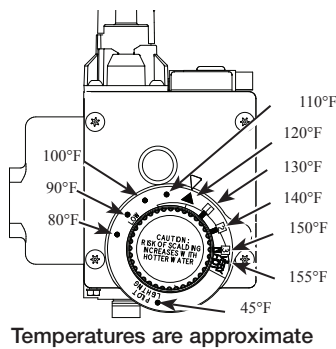

Maximum water temperatures occur just after the burner has shut off. To determine the hot water temperature turn on a hot water faucet and place a thermometer in the hot water stream.

The reference mark ▲ on the rim of the temperature dial, represents an approximate water temperature of 120°F.

The reference Ⓐ or ① mark represents an approximate water temperature of 130°F.

Each reference mark above or below these points indicates an approximate change of 10°F.

To adjust the temperature, turn the temperature dial to an initial setting of 120°F.

A condition known as “stacking” or “layering” can occur when a series of short and frequent hot water draws are taken.

The hottest temperature water will be at the top of the tank, closest to the outlet pipe delivering hot water to the home.

Stacking can cause this top layer of water to be hotter than the water toward the bottom of the tank near the gas control (thermostat).

Therefore, always remember to test the water temperature with your hand before use and remember that hotter water increases the risk of scald injury.

Also, always supervise young children or others who are incapacitated.

The gas control (thermostat) is constructed with a built in safety shut-off device designed to shut off the gas supply to the burner if the pilot flame is extinguished for any reason.

The gas control (thermostat) is also equipped with a single use gas shut off device that will shut off the gas supply to the burner if the water heater exceeds normal operating temperatures. Refer to the (Before You Call For Service) section of this manual, or contact your dealer.

▲WARNING: Should overheating occur or the gas supply fail to shut off, turn off the manual gas control valve to the appliance.

If the water heater has been subjected to fire, flood or physical damage, turn off the manual gas control (shut-off) valve, and do not operate the water heater again until it has been checked by qualified personnel.

NOTICE: Replace any part of the gas control system which has been under water.

Care and cleaning of the water heater.

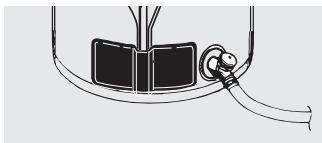

Draining the Water Heater

▲ CAUTION: Shut off gas to the water heater at the gas control (thermostat) gas cock or manual shut-off valve before draining water.

▲ DANGER: Before manually operating the relief valve, make certain no one will be exposed to the hot water released by the valve. The water drained from the tank may be hot enough to present a scald hazard and should be directed to a suitable drain to prevent injury or damage.

In order to drain the water heater, turn off the cold water supply. Open a hot water faucet or lift the handle on the relief valve to admit air to the tank.

Attach a garden hose to the drain valve on the water heater and direct the stream of water to a drain. Open the valve.

▲ DANGER: Before manually operating the relief valve, make certain no one will be exposed to the danger of coming in contact with the hot water released by the valve. The water may be hot enough to create a scald hazard. The water should be released into a suitable drain to prevent injury or property damage.

▲ DANGER: Hotter water increases the potential for Hot Water Scalds.

▲ DANGER: Failure to perform the recommended Routine Preventative Maintenance can harm the proper operation of this water heater, which can cause carbon monoxide dangers, excessive hot water temperatures and other potentially hazardous conditions.

Routine Preventative Maintenance

Properly maintained, your water heater will provide years of dependable trouble-free service.

It is recommended that a periodic inspection of the gas control (thermostat), burner, relief valve, internal flue-way and venting system should be made by service personnel qualified in gas appliance repair.

It is suggested that a routine preventative maintenance program be established and followed by the user.

At least once a year, lift and release the lever handle on the temperature pressure relief valve, located near the top of the water heater, to make certain the valve operates freely. Allow several gallons to flush through the discharge line to an open drain.

NOTICE: If the temperature and pressure relief valve on the hot water heater discharges periodically, this may be due to thermal expansion in a closed water system. Contact the water supplier or your plumbing contractor on how to correct this. Do not plug the relief valve outlet.

A water heater's tank can act as a settling basin for solids suspended

in the water. It is therefore not uncommon for hard water deposits to accumulate in the bottom of the tank. If allowed to accumulate, these solids can cover the gas control (thermostat) sensors, causing the sensors to operate erratically. Because accumulated solids can prevent the gas control (thermostat) sensors from accurately reading the water temperature, the water at the fixture can be hotter than the gas control (thermostat) dial setting. It is suggested that a few quarts (litres) of water be drained from the water heater's tank every month to clean the tank of these deposits.

Rapid closing of faucets or solenoid valves in automatic water using appliances can cause a banging noise heard in a water pipe. Strategically located risers in the water pipe system or water hammer arresting devices can be used to minimize the problem.

The anode rod should be inspected and replaced when more than 6" of core wire is exposed at either end of the rod.

Make sure the cold water supply is turned off before removing anode rod.

Housekeeping

Vacuum around the base of the water heater for dust, dirt and lint on a regular basis.

To insure sufficient ventilation and combustion air supply, proper clearances must be maintained.

▲ DANGER: Combustible materials, such as clothing, cleaning materials, or flammable liquids, etc., must not be placed against or next to the water heater.

Venting System Inspection

The water heater's internal flue must be inspected annually to be certain it is clean by removing the venting system and flue baffle.

Inspect the gas venting system and the chimney.

Make certain the vent system, vent, and air pipes is properly sealed and securely attached.

If after inspection of the vent system you found sooting or deterioration call the local gas utility to correct the problem and clean or replace the flue and venting before resuming operation of the water heater.

Burner Inspection

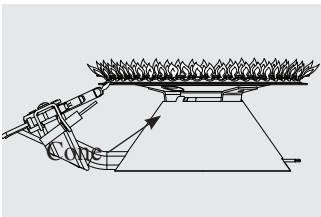

Proper burner and pilot flame pattern.

▲ CAUTION: Cone is used only on natural gas burner assemblies.

Visually inspect the pilot and main burners annually.

Through the sight glass, inspect the pilot burner flame with the main burner off and inspect the main burner while firing.

If any unusual burner operation is noted, the water heater should be shut off until qualified service assistance can be obtained.

▲ CAUTION: For your safety, cleaning of the burner must be performed only by qualified service personnel. The burner chamber is a sealed area. If the burner access door is removed, the burner access door gasket must be replaced.

For cleaning, remove the burner from the water heater. A vacuum cleaner can be used on the burner and floor shield inside the water heater. The burner can also be cleaned by scrubbing with mild detergent.

Vacation and Extended Shut-Down

NOTICE: Refer to the Hydrogen Gas Caution in the Operating Instructions.

If the water heater is to remain idle for an extended period of time, the power and water to the appliance should be turned off to conserve energy and prevent a build-up of dangerous hydrogen gas.

The water heater and piping should be drained if they might be subjected to freezing temperatures.

After a long shut-down period, the water heater's operation and controls should be checked by qualified service personnel. Make certain the water heater is completely filled again before placing it in operation.

Anode Rod

NOTICE: Do not remove the anode rod from the water heater's tank, except for inspection and/or replacement, as operation with the anode rod removed will greatly shorten the life of the glass lined tank and will exclude warranty coverage.

This water heater is equipped with an anode rod designed to prolong the life of the glass lined tank. The anode rod is slowly consumed, thereby eliminating or minimizing corrosion of the glass-lined tank.

Water sometimes contains a high sulfate and/or mineral content and together with cathodic protection process can produce a hydrogen sulfide, or rotten egg odor in the heated water. Chlorination of the water supply should minimize the problem.

Before You Call For Service...



Troubleshooting Tips

Save time and money! Review the charts on the following pages first and you may not need to call for service.

Problem	Possible Causes	What To Do
Condensation	This usually happens when a new water heater is filled for the first time.	<ul style="list-style-type: none"> ● This is normal. After the water in the tank warms up the condensation will disappear. If, however, the condition persists, examine the piping and fittings for possible leaks.
	Moisture from the products of combustion condensing on the tank surface.	<ul style="list-style-type: none"> ● This is normal and will disappear in time. Excessive condensation can cause pilot outage.
	An undersized water heater will cause condensation.	<ul style="list-style-type: none"> ● Use a water heater size that meets the requirements of your needs. ● Contact a qualified service technician for service.
Yellow flame or sooting	Scale on top of the burner.	<ul style="list-style-type: none"> ● Contact a qualified service technician for service.
	Combustion air inlets or flue-way restricted.	<ul style="list-style-type: none"> ● Remove lint or debris and inspect air inlet opening for restriction.
	Not enough combustion or ventilation air supplied to the water heater location.	<ul style="list-style-type: none"> ● Proper operation of the water heater requires air for combustion and ventilation. See the Combustion and Ventilation Air information in the Locating the water heater section of this manual.
	Improper fuel or fuel conversion	<ul style="list-style-type: none"> ● Check fuel type and Contact a qualified service technician to specify fuel type.
	Wrong main burner assembly	<ul style="list-style-type: none"> ● Contact a qualified service technician for service.
Unable to light the pilot	Air in gas line.	<ul style="list-style-type: none"> ● Contact a qualified service technician to purge the air from the gas line.
	Pilot burner/orifice clogged.	<ul style="list-style-type: none"> ● The pilot should be cleaned or replaced by a qualified service technician.
	Pilot tube pinched or clogged.	<ul style="list-style-type: none"> ● The pilot should be cleaned, repaired or replaced by a qualified service technician.
	Gas Cock Knob not positioned correctly.	<ul style="list-style-type: none"> ● See the "Lighting the Water Heater" section of this manual.
Pilot does not stay lit when the RED	Loose thermocouple.	<ul style="list-style-type: none"> ● The connection at the gas control (thermostat) should be tightened by a qualified service technician.
	Thermocouple defective.	<ul style="list-style-type: none"> ● The thermocouple should be replaced by a qualified service technician.
	Safety magnet defective.	<ul style="list-style-type: none"> ● The gas control (thermostat) should be replaced by a qualified service technician.
	Gas Control (thermostat's) single use gas shut-off device has opened.	<ul style="list-style-type: none"> ● The gas control (thermostat) should be replaced by a service technician.

▲ CAUTION: For your safety **DO NOT** attempt repair of gas piping, gas control (thermostat), burners, vent connectors or other safety devices. Refer repairs to qualified service personnel.



Troubleshooting Tips

Save time and money! Review the charts on the following pages first and you may not need to call for service.

Problem	Possible Causes	What To Do
Rumbling noise	Scale and sediment in tank.	● Clean tank.
Relief valve producing popping noise or draining	Pressure build up caused by thermal expansion to a closed system.	● This is an unacceptable condition and must be corrected. Contact the water supplier or plumbing contractor on how to correct this. Do not plug the relief valve outlet.
Rattling noise during periods of water usage	Internal heat trap fittings in operation.	● This is normal for heat trap fittings when in operation and does not indicate a need for service.
Not enough or no hot water	Water usage may have exceeded the capacity of the water heater.	● Wait for the water heater to recover after an abnormal demand.
	Low gas pressure.	● Check gas supply pressure and manifold pressure.
	The pilot burner may be out.	● Check the pilot. If necessary, relight using the instructions in the "Lighting the Water Heater" section of this manual.
	The gas control (thermostat) may be set too low.	● See the "Water Temperature Setting" of the water heater section of this manual.
	Leaking or open hot water faucets.	● Make sure all faucets are closed.
	Cold water inlet temperature may be colder during the winter months.	● This is normal. The colder inlet water takes longer to heat.
Water is too hot	The gas control (thermostat) is set too high.	● See the "Temperature Setting of the Water Heater" section of this manual.
	Gas control (thermostat) defective	● Contact a qualified service technician to replace the gas control (thermostat).

▲ CAUTION: For your safety **DO NOT** attempt repair of gas piping, thermostat, burners, vent connectors or other safety devices. Refer repairs to qualified service personnel.

Replacement Parts.

Instructions For Placing a Parts Order

All parts orders should include:

- 1 The model and serial number of the water heater from the rating plate.
- 2 Specify type of gas (natural or LP) as marked on the rating plate.

- 3 Part description (as noted below) and number of parts desired.

⚠ CAUTION: For your safety **DO NOT** attempt repair of gas piping, gas control (thermostat), burners, vent connectors or other safety devices. Refer repairs to qualified service personnel.

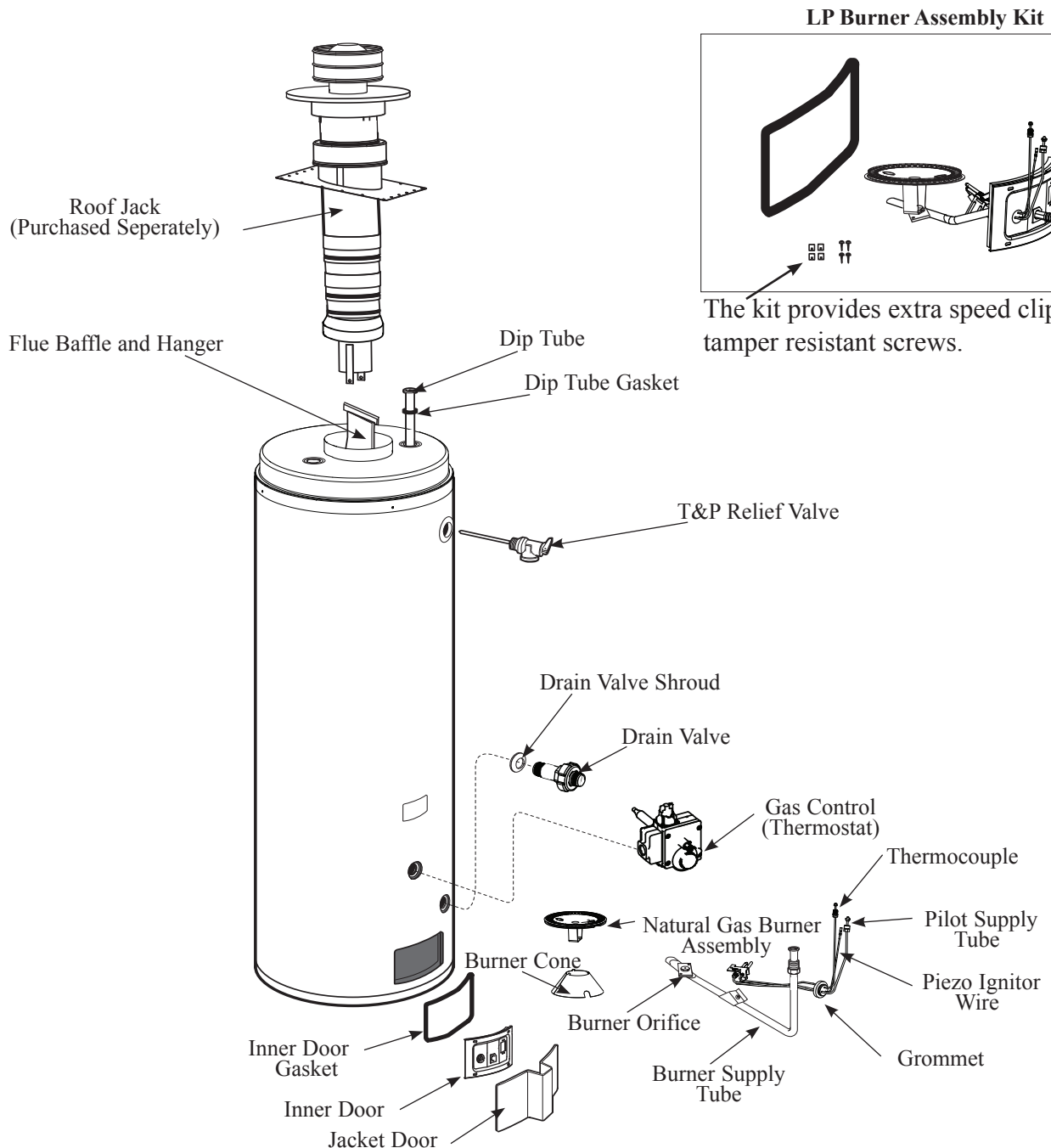

Conversion instructions—Natural Gas to LP Gas

If your gas supply is LP gas, your water heater can be converted to burn LP gas as follows:

Natural Gas to Liquefied Petroleum (LP or Propane) Gas

⚠ WARNING: This conversion kit must be installed by a qualified installer or service technician in accordance with these instructions. Installation must conform with local codes, or in their absence, with the latest edition of the National Fuel Gas Code, ANSI Z223.1. Failure to follow instructions could result in serious injury or property damage. The qualified agency performing this work assumes responsibility for this conversion.

⚠ CAUTION: The water heater is factory set to burn natural gas, but can be converted to burn LP gas. Before placing the water heater into operation, verify that the type of gas supplied to your water heater and the type of gas your water heater is set to burn are the same. If they are not, refer to these instructions.

NOTICE: The parts required to make this conversion are supplied in a bag attached to the water heater. Should your heater not have this bag attached to the water heater, a replacement can be obtained. Simply contact the manufacturer at the address below and request a replacement conversion kit.

Customer Service Department

1241 Carwood Court

Montgomery, AL 36117

Phone: 1-800-432-8373

Tools Required:

#20 Torx Wrench (Included)

#2 Phillips Screwdriver

3/4" Wrench

7/16" Wrench

3/8" Wrench

5/16" Wrench

- 1 Turn manual gas shut off valve to the OFF position to shutoff gas to the thermostat.
- 2 Set the thermostat dial to the lowest setting by turning the thermostat dial clockwise until it stops. DO NOT FORCE.
- 3 Slightly depress the gas control knob and turn clockwise to "OFF" position. NOTICE: Knob cannot be turned from "PILOT" position unless pushed down slightly. DO NOT USE FORCE.
- 4 Change gas regulators setting by removing cover from the gas selector screw; then remove and reinstall the selector screw with the red washer and LP arrow mark pointing inward toward the heater. Tighten to 4-8 in-lb. Replace cover.

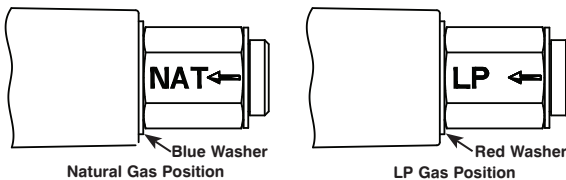
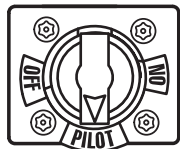

Gas Selector Screw Settings

Front View of Gas Thermostat

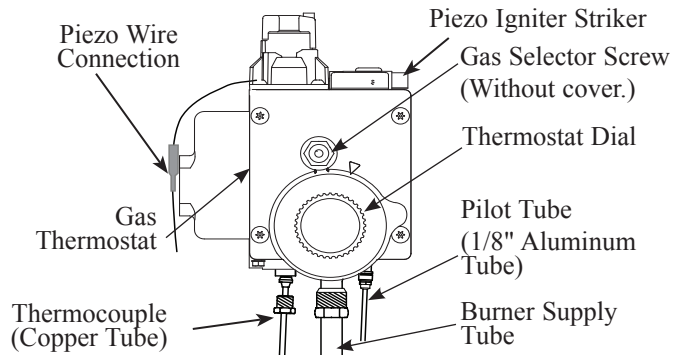

- 5 Remove outer jacket door.

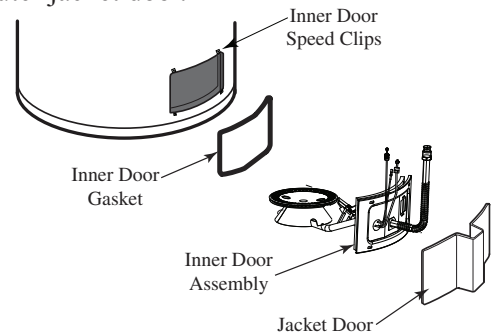

- 6 Remove the four screws on the inner door using a #20 TORX wrench supplied with the conversion kit. Disconnect burner supply tube using the 3/4" wrench, pilot tube using the 7/16" wrench, and the thermocouple using the 3/8" wrench from the thermostat. Disconnect the piezo wire from piezo igniter striker connection. Remove the entire burner assembly along with the inner door.

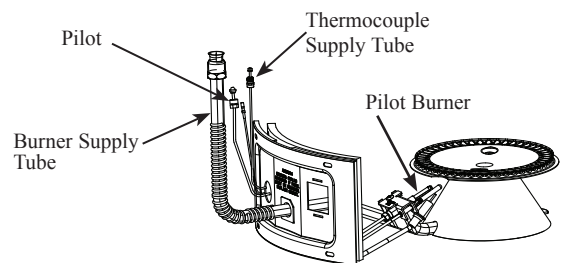

- 7 Remove the Phillips head screw that holds the pilot burner assembly in place. Remove the pilot burner assembly from the burner bracket. Remove the two #6 x 3/8" long Phillips head screws from the burner bracket and remove the burner from inner door assembly to expose main burner orifice.

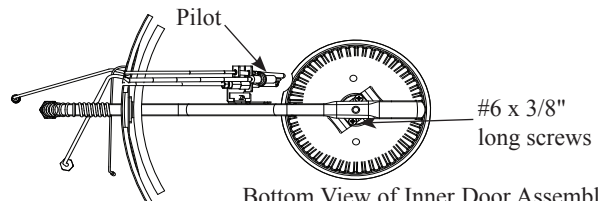

Bottom View of Inner Door Assembly

Conversion Instructions—Natural Gas to LP Gas

- 8** Slide the cone to the end of the burner tube to remove the flat end from the closed slot, turn the burner supply tube so the narrow side slides out of the cone.

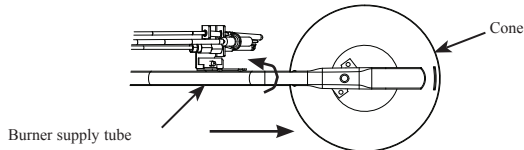

- 9** Remove main burner orifice. Replace main burner natural gas orifice with the **Red colored main burner orifice (stamped LP)** supplied in the bag.

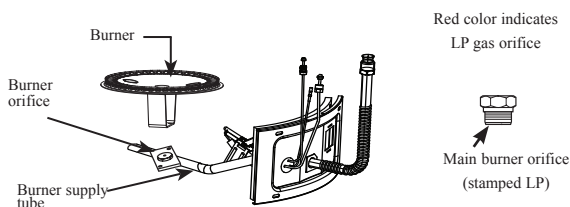

- 10** Remove the compression nut from the pilot burner assembly using the 3/8" and 5/16" wrench to expose pilot burner orifice. Remove natural gas pilot burner orifice and replace with **Yellow marked LP pilot burner orifice** supplied in the package. Replace the compression nut on pilot burner assembly and tighten the nut.

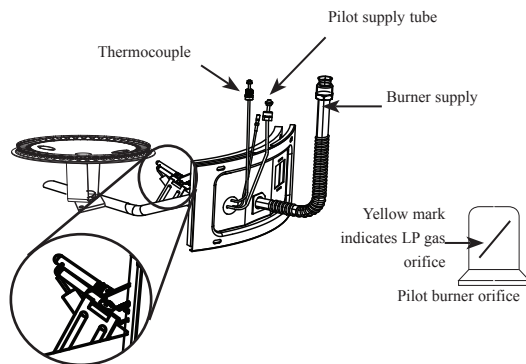

- 11** Replace main burner (Natural gas) with the (Red) colored (LP) main burner supplied in the package. Reinstall the two #6 x 3/8" long Phillips head screws. Screw the pilot burner assembly to the burner bracket using the Phillips head screw removed on step 7.



- 12** Remove the gasket from inner door. Clean the metal surfaces to assure good adhesion of new gasket (supplied in bag) to the inner door. Align screw holes of new gasket with holes on inner door and press gasket firmly in place.

- 13** Reinstall entire inner door assembly to the heater. Ensure the speed clips are in place and the gasket is fully sealed. Attach inner door loosely to the heater using four #20 TORX screws. Reconnect and tighten burner supply, pilot tube and thermocouple at the thermostat. Handle tubes carefully to avoid damaging them. **DO NOT** over-tighten or cross-thread the connections. Now tighten the four #20 TORX screws to secure the inner door firmly to the heater. Reconnect the piezo wire to the piezo ignitor striker connection.

- 14** Attach green CAUTION label from the bag to the outside of the water heater near the gas control. Label should be signed by qualified installer or service organization

- 15** Return the unused parts to the bag for possible future conversions. Return the bag and this Use and Care manual to the plastic bag attached to the water heater.

- 16** Install outer jacket door to heater.

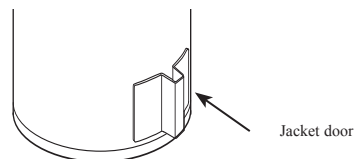

- 17** Turn manual gas shut off valve to the ON position to start gas flow to the thermostat. Leak test all gas connections and caps with soap/water solution. Bubbles indicate a leak. Make certain all leaks have been repaired, and the outer jacket door has been replaced.

- 18** Follow lighting instructions on page 15 of the manual to start the water heater.

Conversion instructions—LP Gas to Natural Gas

Your water heater was factory pre-set to burn natural gas but may have been converted to burn LP gas. If your water heater has been converted to burn LP Gas, and your gas supply is now natural gas, your water heater can be converted to burn natural gas as follows:

Liquefied Petroleum (LP or Propane) to Gas Natural Gas

⚠ WARNING: This conversion kit must be installed by a qualified installer or service technician in accordance with these instructions. Installation must conform with local codes, or in their absence, with the latest edition of the National Fuel Gas Code, ANSI Z223.1. Failure to follow instructions could result in serious injury or property damage. The qualified agency performing this work assumes responsibility for this conversion.

⚠ CAUTION: The water heater is factory set to burn natural gas, but can be converted to burn LP gas. Before placing the water heater into operation, verify that the type of gas supplied to your water heater and the type of gas your water heater is set to burn are the same. If they are not, refer to these instructions.

NOTICE: The parts required to make this conversion are supplied in a bag attached to the water heater. Should your heater not have this bag attached to the water heater, a replacement can be obtained. Simply contact the manufacturer at the address below and request a replacement conversion kit.

Customer Service Department
1241 Carwood Court
Montgomery, AL 36117
Phone: 1-800-432-8373

Tools Required:

- #20 Torx Wrench (Included)
- #2 Phillips Screwdriver
- 3/4" Wrench
- 7/16" Wrench
- 3/8" Wrench
- 5/16" Wrench

- 1 Turn manual gas shut off valve to the OFF position to shutoff gas to the thermostat.
- 2 Set the thermostat dial to the lowest setting by turning the thermostat dial clockwise ↻ until it stops. DO NOT FORCE.
- 3 Slightly depress the gas control knob and turn clockwise ↻ to "OFF" position. NOTICE: Knob cannot be turned from "PILOT" position unless pushed down slightly. DO NOT USE FORCE.
- 4 Change gas regulator setting by removing cover from the gas selector screw; then remove and reinstall the selector screw with the blue washer and NAT arrow mark pointing inward toward the heater. Tighten to 4-8 in lb. Replace cover.

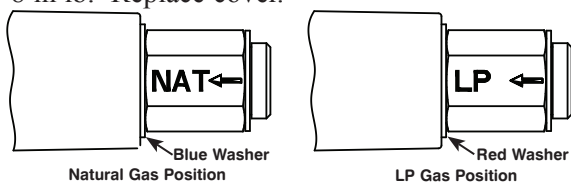
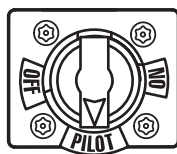

Gas Selector Screw Settings

Front View of Gas Thermostat

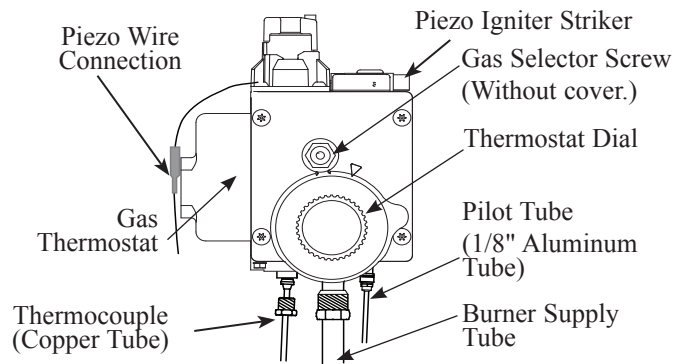

- 5 Remove outer jacket door.
- 6 Remove the four screws on the inner door using a #20 TORX wrench supplied with the conversion kit. Disconnect burner supply tube using the 3/4" wrench, pilot tube using the 7/16" wrench, and the thermocouple using the 3/8" wrench from the thermostat. Disconnect the piezo wire from the piezo igniter striker connection. Remove the entire burner assembly along with the inner door.

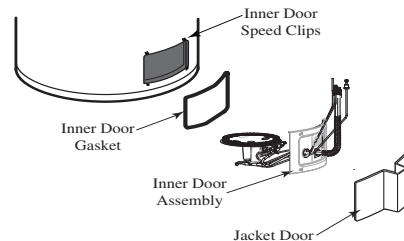

- 7 Remove the Phillips head screw that holds the pilot burner assembly in place. Remove the pilot burner assembly from the burner bracket. Remove the two #6 x 3/8" long Phillips head screws from the burner bracket and remove the burner from inner door assembly to expose main burner orifice.

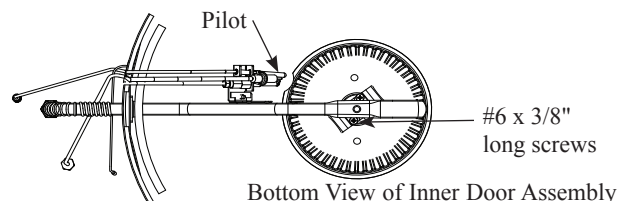
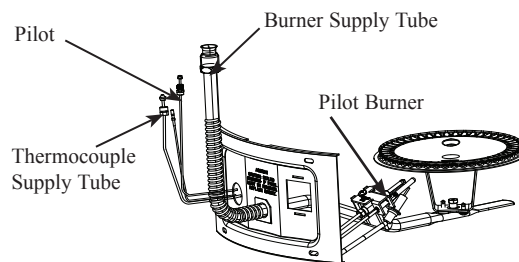

Bottom View of Inner Door Assembly

Conversion instructions—LP Gas to Natural Gas

- 8** Remove LP burner orifice. Replace Red marked LP gas burner orifice with the main burner orifice stamped NG supplied in the bag.

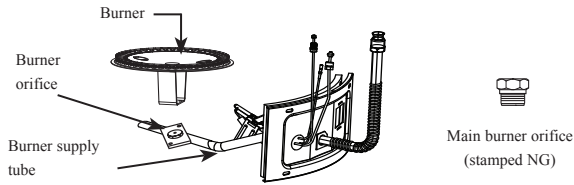

- 9** Slide the notch on the cone onto the flat part of the burner tube, then turn the cone upright and slide the flat end of the burner supply tube into the closed slot.

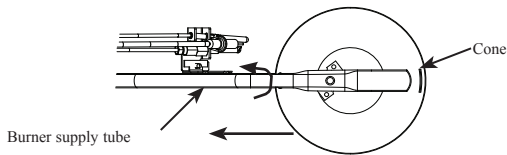

- 10** Remove the compression nut from the pilot burner assembly using the 3/8" and 5/16" wrench to expose pilot burner orifice. Remove natural gas pilot burner orifice and replace with **Yellow marked LP pilot burner orifice** supplied in the package. Replace the compression nut on pilot burner assembly and tighten the nut.

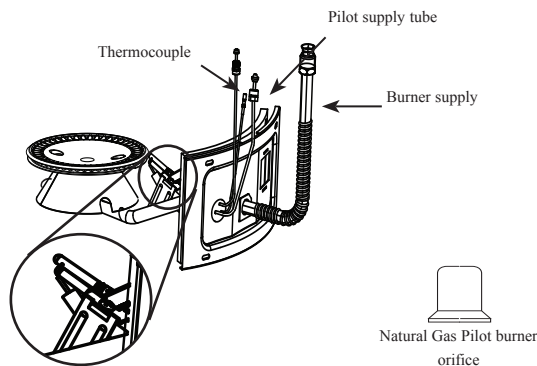

- 11** Replace **Red marked LP main burner** with main burner (Natural gas) supplied in the package. Reinstall the two #6 x 3/8" long Phillips head screws. Screw the pilot burner assembly to the burner bracket using the Phillips head screw removed on step 7.

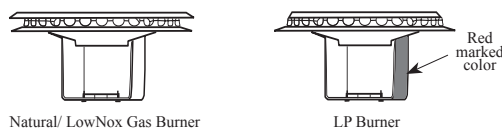

- 12** Remove the gasket from inner door. Clean the metal surfaces to assure good adhesion of new gasket (supplied in bag) to the inner door. Align screw holes of new gasket with holes on inner door and press gasket firmly in place.

- 13** Reinstall entire inner door assembly to the heater. Ensure the speed clips are in place and the gasket is fully sealed. Attach inner door loosely to the heater using four #20 TORX screws. Reconnect and tighten burner supply, pilot tube and thermocouple at the thermostat. Handle tubes carefully to avoid damaging them. **DO NOT** over-tighten or cross-thread the connections. Now tighten the four #20 TORX screws to secure the inner door firmly to the heater. Reconnect the piezo wire to the piezo ignitor striker connection.

- 14** Attach green CAUTION label from the bag to the outside of the water heater near the gas control. Label should be signed by qualified installer or service organization

- 15** Return the unused parts to the bag for possible future conversions. Return the bag and this Use and Care manual to the plastic bag attached to the water heater.

- 16** Install outer jacket door to heater.

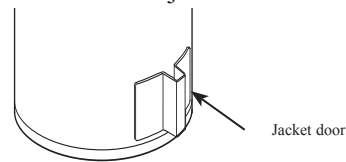

- 17** Turn manual gas shut off valve to the ON position to start gas flow to the thermostat. Leak test all gas connections and caps with soap/water solution. Bubbles indicate a leak. Make certain all leaks have been repaired and the outer jacket door has been replaced.

- 18** Follow lighting instructions on page 15 of the manual to start the water heater.

Notes

IF YOU NEED SERVICE



1. Should you have any questions about your new water heater, or if it requires adjustment, repair, or routine maintenance, it is suggested that you first contact your installer, plumbing contractor or previously agreed upon service agency. In the event the firm has moved, or is unavailable, refer to the telephone directory, commercial listings or local utility for qualified service assistance.

2. Should your problem not be solved to your complete satisfaction, you should then contact the Manufacturer's National Service Department at the following address:

1241 Carwood Court
Montgomery, Alabama 36117
Phone: 1-800-432-8373.

When contacting the manufacturer, the following information will be requested:

- a. Model and serial number of the water heater as shown on the rating plate attached to the jacket of the heater.
- b. Address where the water heater is located and physical location.
- c. Name and address of installer and any service agency who performed service on the water heater.
- d. Date of original installation and dates any service work was performed.
- e. Details of the problems as you can best describe them.
- f. List of people, with dates, who have been contacted regarding your problem.